

Wireflow Chandelier

Design by Arik Levy

Wireflow is a collection of pendant lights that are at once presence and absence. Featuring slender black, electrical cables tipped with LED light terminals, its three-dimensional forms represent a contemporary reinterpretation of the traditional chandelier.

Pendants

0315

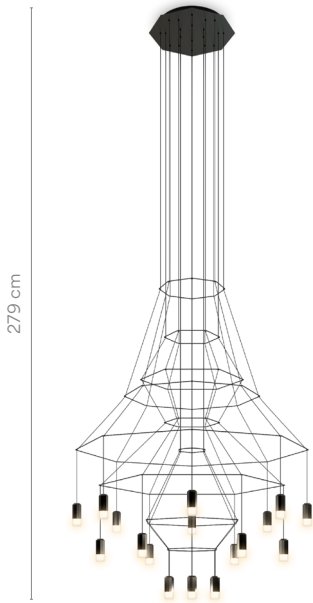

0374

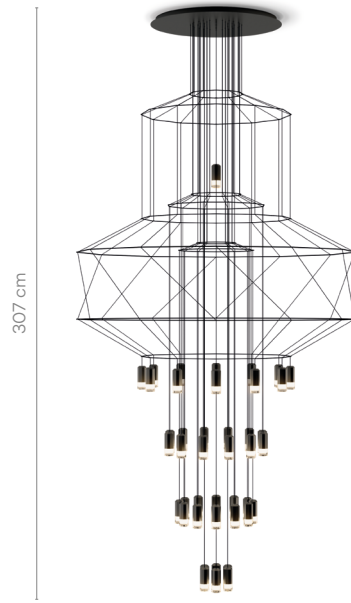

0375

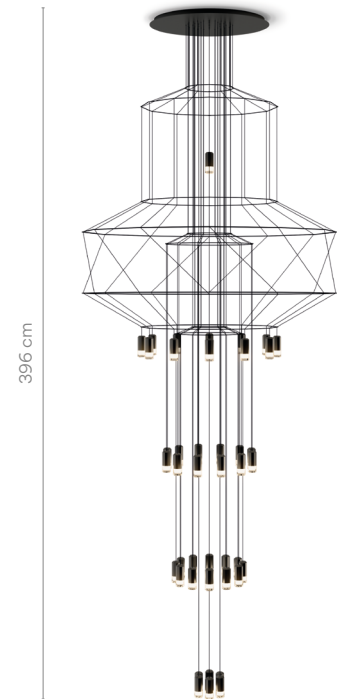

0376

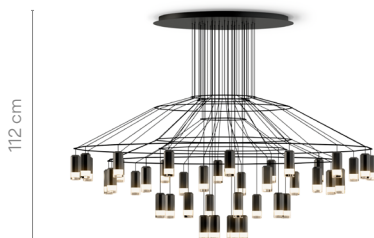

0377

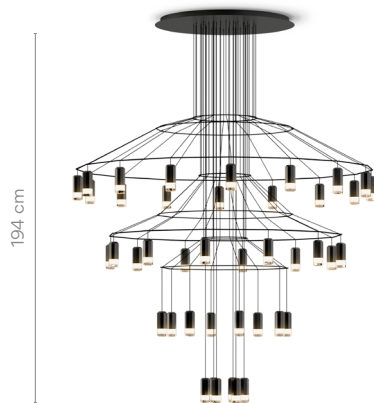

0378

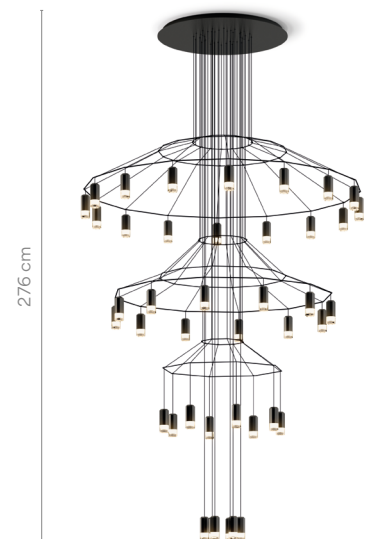

Each project is unique. Visit vibia.com and chose among multiple compositions designed and adapted to your project needs.

Personalise your own Wireflow composition quick and easy at vibia.com

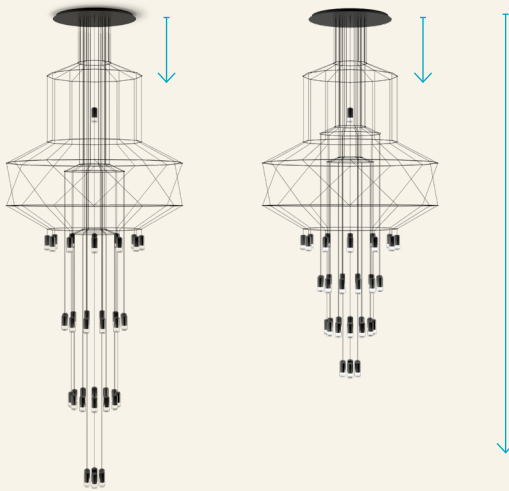
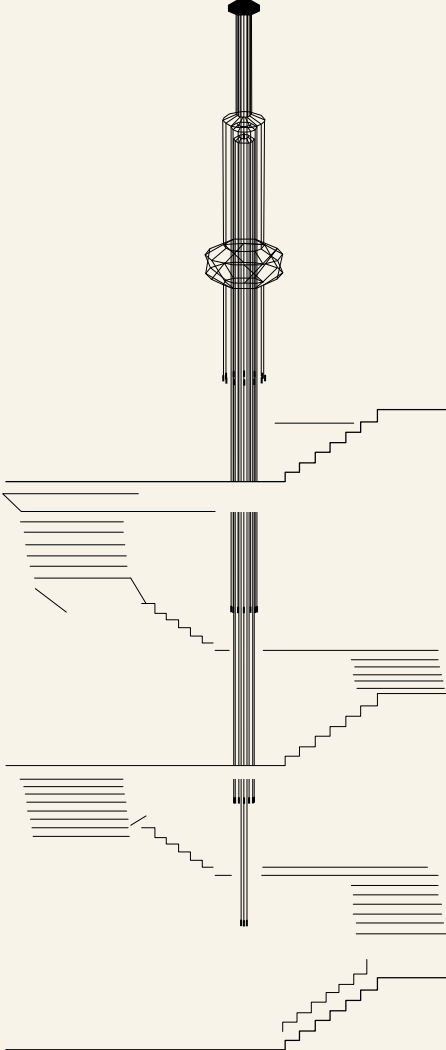

For configurations longer than 9 m, please ask Vibia customer service.



Wireflow Chandelier

0315

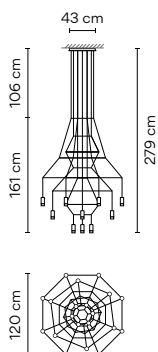

Finishes ● 04/ __ Black (RAL 9005)	LED temperature colour /1 _ 2700 K CRI >90 9700 lm 121 lm/W	Control 0315 __ / _ A DALI-2, 1-10V, Push <hr/> 0315 __ / _ Z Casambi
	/2 _ 3000 K CRI >90 9700 lm 121 lm/W	
	/3 _ 3500 K CRI >90 10006,1 lm 125,1 lm/W	

Materials Diffuser: Pressed-glass. Body: Aluminum. Canopy and horizontal rods: Steel.	Packaging 2 Boxes Total Vol 0,3832 m³ Gross weight 32 Kg Net weight 18 Kg
Light Source and electronics 20 x LED 4,5 W 700 mA Constant Current 700 mA 100~240V 50/60Hz	Notes Configuration layout at vibia.com

0374

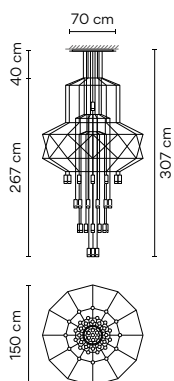

Finishes ● 04/ __ Black (RAL 9005)	LED temperature colour /1 _ 2700 K CRI >90 20855 lm 121 lm/W	Control 0374 __ / _ A DALI-2, 1-10V, Push <hr/> 0374 __ / _ Z Casambi
	/2 _ 3000 K CRI >90 20855 lm 121 lm/W	
	/3 _ 3500 K CRI >90 21513,1 lm 125,1 lm/W	

Materials Diffuser: Pressed-glass. Body: Aluminum. Canopy and horizontal rods: Steel.	Packaging 2 Boxes Total Vol 0,5000 m³ Gross weight 57 Kg Net weight 47 Kg
Light Source and electronics 43 x LED 4,5 W 700 mA Constant Current 700 mA 100~240V 50/60Hz	Notes Configuration layout at vibia.com

0375

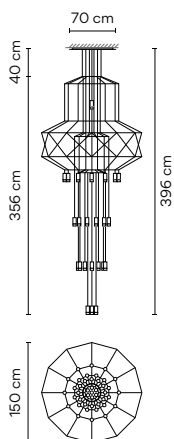

Finishes ● 04/ __ Black (RAL 9005)	LED temperature colour /1 _ 2700 K CRI >90 20855 lm 121 lm/W	Control 0375 __ / _ A DALI-2, 1-10V, Push <hr/> 0375 __ / _ Z Casambi
	/2 _ 3000 K CRI >90 20855 lm 121 lm/W	
	/3 _ 3500 K CRI >90 21513,1 lm 125,1 lm/W	

Materials Diffuser: Pressed-glass. Body: Aluminum. Canopy and horizontal rods: Steel.	Packaging 2 Boxes Total Vol 0,5000 m³ Gross weight 57 Kg Net weight 47 Kg
Light Source and electronics 43 x LED 4,5 W 700 mA Constant Current 700 mA 100~240V 50/60Hz	Notes Configuration layout at vibia.com

0376

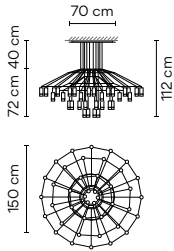

Finishes
 ● 04/ _ _ Black
 (RAL 9005)

LED temperature colour
 /1 _ 2700 K
 CRI >90 20370 lm 121 lm/W
 /2 _ 3000 K
 CRI >90 20370 lm 121 lm/W
 /3 _ 3500 K
 CRI >90 21012,8 lm 125,1 lm/W

Control
 0376 _ _ / _ A
 DALI-2, 1-10V, Push
 0376 _ _ / _ Z
 Casambi

Materials
 Diffuser: Pressed-glass. Body: Aluminum.
 Canopy and horizontal rods: Steel.

Light Source and electronics
 42 x LED 4,5 W 700 mA
 Constant Current 700 mA
 100~240V 50/60Hz

Packaging
 2 Boxes
 Total Vol 0,5000 m³
 Gross weight 56 Kg Net weight 46 Kg

Notes
 Configuration layout at vibia.com



0377

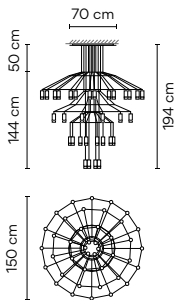

Finishes
 ● 04/ _ _ Black
 (RAL 9005)

LED temperature colour
 /1 _ 2700 K
 CRI >90 20370 lm 121 lm/W
 /2 _ 3000 K
 CRI >90 20370 lm 121 lm/W
 /3 _ 3500 K
 CRI >90 21012,8 lm 125,1 lm/W

Control
 0377 _ _ / _ A
 DALI-2, 1-10V, Push
 0377 _ _ / _ Z
 Casambi

Materials
 Diffuser: Pressed-glass. Body: Aluminum.
 Canopy and horizontal rods: Steel.

Light Source and electronics
 42 x LED 4,5 W 700 mA
 Constant Current 700 mA
 100~240V 50/60Hz

Packaging
 2 Boxes
 Total Vol 0,5000 m³
 Gross weight 56 Kg Net weight 46 Kg

Notes
 Configuration layout at vibia.com



0378

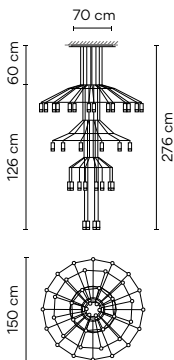

Finishes
 ● 04/ _ _ Black
 (RAL 9005)

LED temperature colour
 /1 _ 2700 K
 CRI >90 20370 lm 121 lm/W
 /2 _ 3000 K
 CRI >90 20370 lm 121 lm/W
 /3 _ 3500 K
 CRI >90 21012,8 lm 125,1 lm/W

Control
 0378 _ _ / _ A
 DALI-2, 1-10V, Push
 0378 _ _ / _ Z
 Casambi

Materials
 Diffuser: Pressed-glass. Body: Aluminum.
 Canopy and horizontal rods: Steel.

Light Source and electronics
 42 x LED 4,5 W 700 mA
 Constant Current 700 mA
 100~240V 50/60Hz

Packaging
 2 Boxes
 Total Vol 0,5000 m³
 Gross weight 56 Kg Net weight 46 Kg

Notes
 Configuration layout at vibia.com

